

Warmup

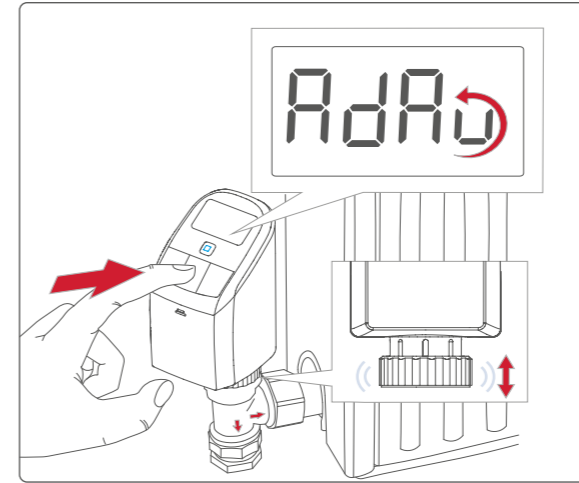

Step 2 - Connect Smart Hub

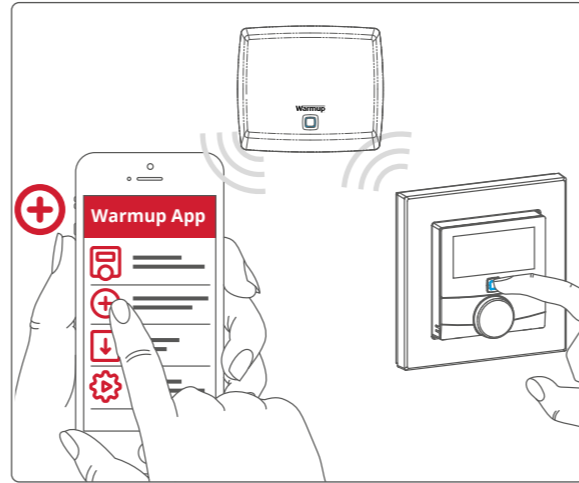
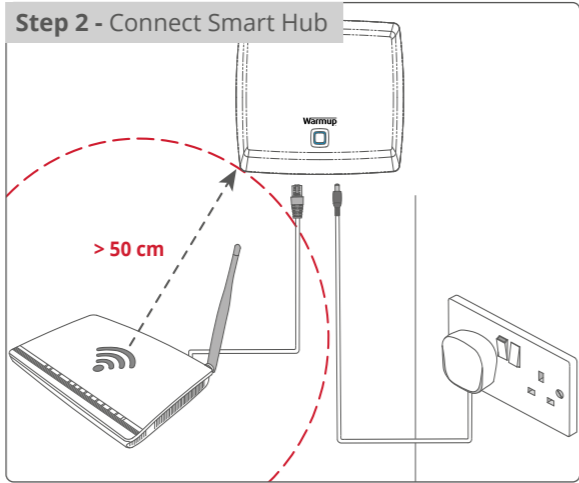

Step 6a - Connect Only UFH or Only Rads

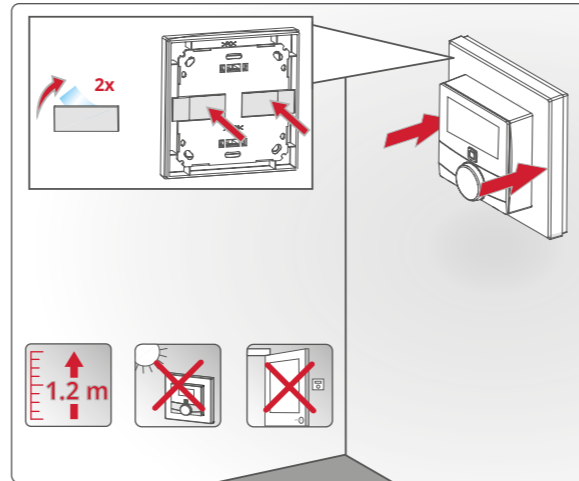
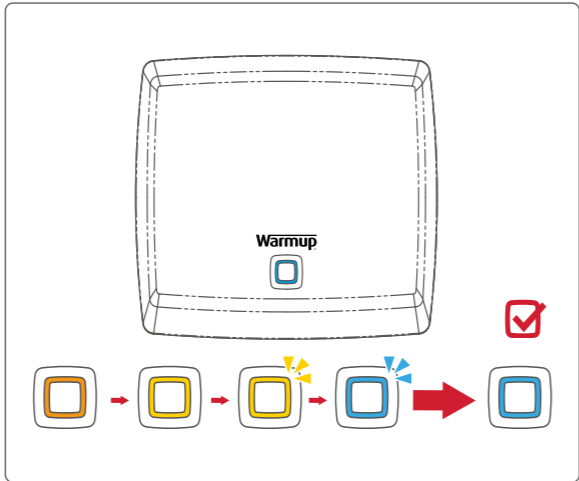
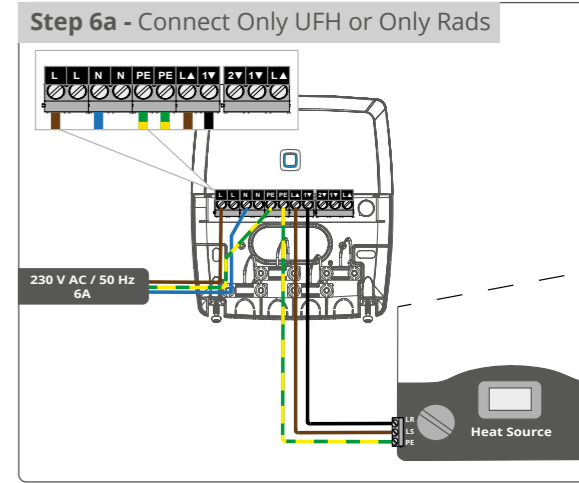

Step 5 - Connect Wiring Centre

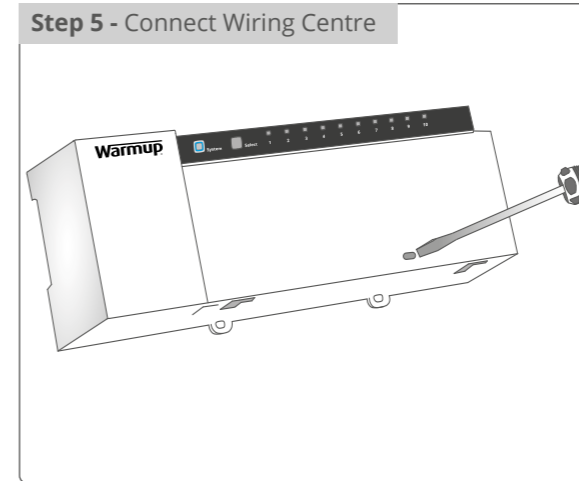

Step 6b - Connect UFH with Rads or DHW

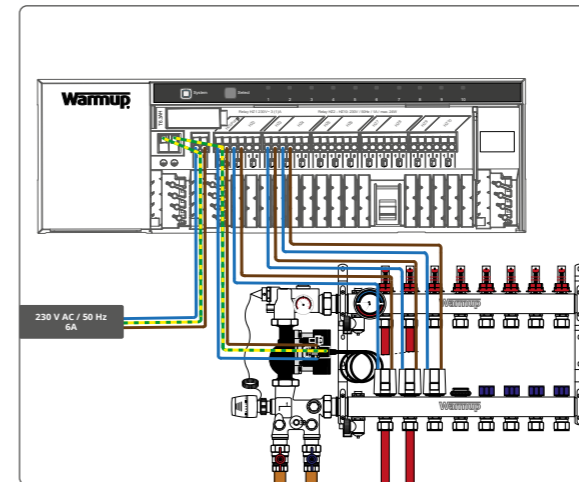
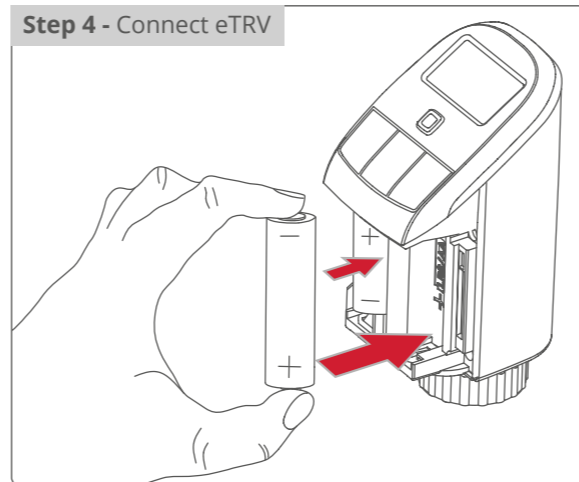
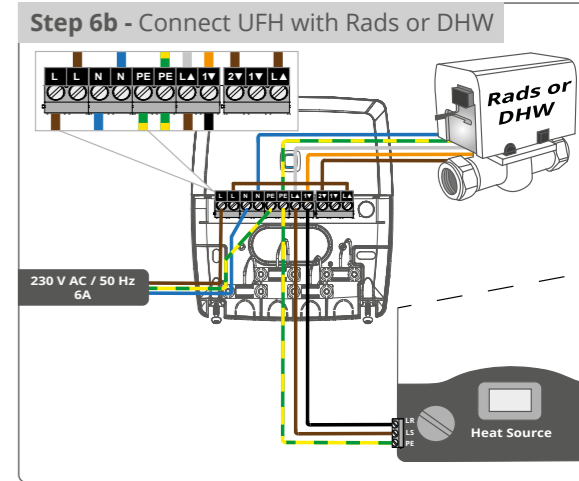

Step 6c - Connect Rads & DHW

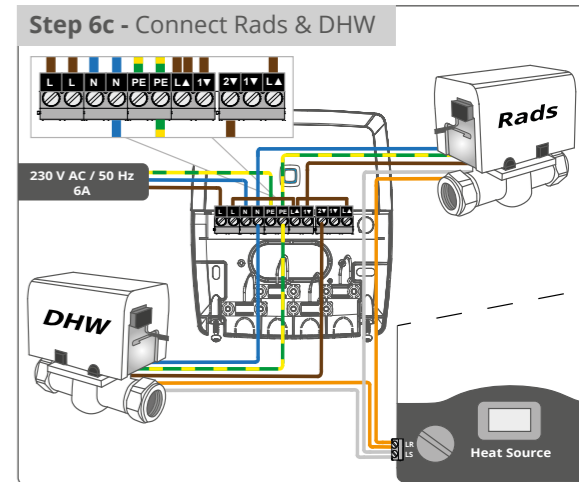

Step 3 - Connect Thermostat

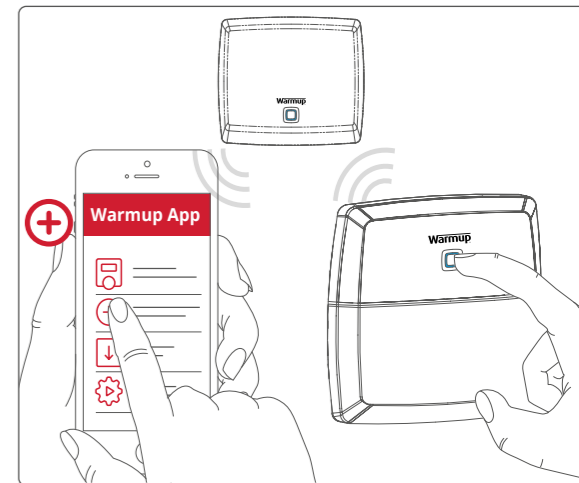
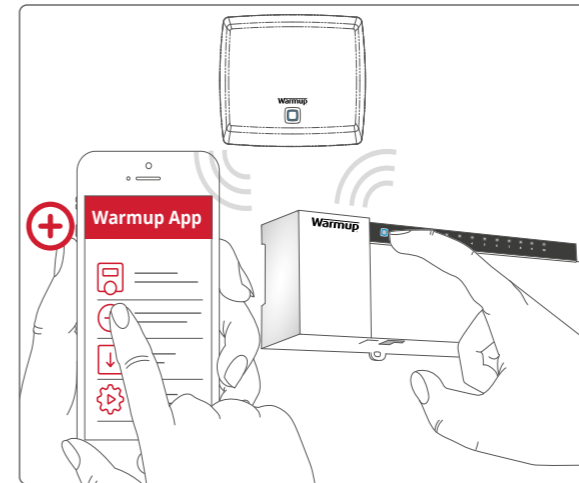
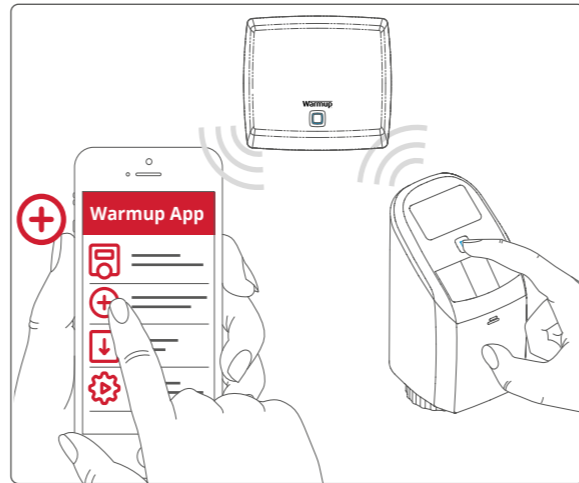
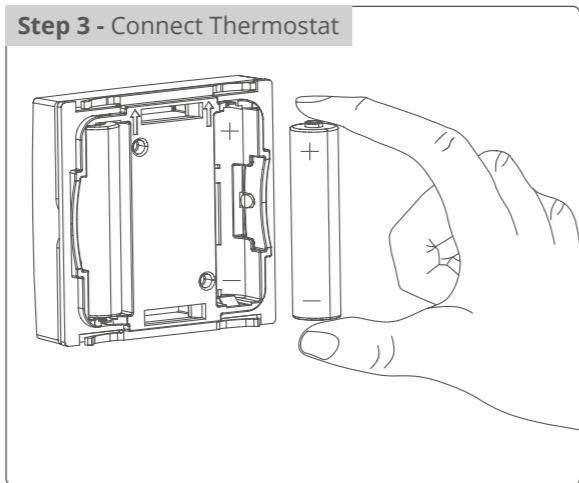

konekt WIRELESS

- Smart Hub
- eTRV
- Thermostat with Humidity Sensor
- Boiler 2-Channel Switch
- 230 V 10-Channel Wiring Centre



Technical Helpline
0345 345 2288
www.warmup.co.uk

Warmup plc • 704 Tudor Estate
Abbey Road • London • NW10 7UW • UK
Warmup GmbH • Ottostraße 3 • 27793 Wildeshausen • DE

Quick start guide

This quick start guide will get your hUFH, radiator and DHW system operational with minimal fuss by focussing solely on its core functions.

IMPORTANT: This is a Quick Start Guide ONLY and should be read in conjunction with the FULL product manuals!

Please scan the QR code on the cover page of this manual to view full product manuals or to use any of the konekt's wireless products extended functionality, such as cooling control, or commissioning the system without internet access.

These manuals should be read carefully before commencing operation of your konekt wireless products. Always retain the product manuals for future use.

Step 1 - Download the App





Technical Specifications

Warmup konekt Wireless Smart Hub	
The Smart Hub is the central unit of the Warmup konekt Wireless System.	
It connects smartphones via the Warmup App and transmits configuration data and control commands from the App to all Warmup konekt Wireless devices.	
Product Code	KW-UKHUB
Operating Voltage	100 - 240 V AC / 50 Hz
Supply Voltage	5 VDC
Current Consumption	500 mA max.
Power Consumption, Plug-in Mains Adapter	2.5 W max.
Standby Power Consumption	1.1 W
IP Rating	IP20
Ambient Temperature	5 to 35 °C
Dimensions (W x H x D)	118 x 104 x 26 mm
Weight	153 g
Radio Frequency Band	868.0-868.6 MHz, 869.4-869.65 MHz
Maximum Radiated Power	10 dBm max.
Receiver Category	SRD category 2
Type Open Area RF Range	400 m
Duty Cycle	< 1 % per h/< 10 % per h
Network	10/100 MBit/s, Auto-MDIX









Warmup konekt Wireless eTRV	
The eTRV offers modulating time and temperature control of rooms heated with radiators. Can be used with other devices to create a connected multi-zone system. Use in conjunction with the Thermostat for more accurate temperature regulation.	
The eTRV fits to all common radiator valves and is easy to mount – without having to drain any water or intervene in the heating system.	
Product Code	KW-UKETRV
Supply voltage	2x 1.5 V LR6/mignon/AA
Current consumption	100 mA max.
Battery life	2 years (typ.)
IP Rating	IP20
Ambient temperature	0 to 50 °C
Dimensions (W x H x D)	56 x 115 x 67 mm
Weight	180 g (incl. batteries)
Radio frequency band	868.0-868.6 MHz, 869.4-869.65 MHz
Maximum radiated power:	10 dBm
Receiver category	SRD category 2
Typ. open area RF range	250 m
Duty cycle	< 1 % per h/< 10 % per h
Software class	Class A
Method of operation	Type 1
Degree of pollution	2
Valve Connection	M30 x 1.5 mm

Warmup konekt Wireless Thermostat with Humidity Sensor	
The thermostat offers precise time and temperature control of floor heating or radiator systems when combined with the Wiring Centre or eTRV's.	
The Thermostat measures both temperature and humidity in a room.	
Product Code	KW-STATH
Supply Voltage	2x 1.5 V LR03/micro/AAA
Current consumption	50 mA max.
Battery life	2 years (typ.)
IP Rating	IP20
Ambient temperature	0 to 35 °C
Dimensions (W x H x D)	55 x 55 x 23.5 mm / 86 x 86 x 25 mm (incl. frame)
Weight	100 g (incl. batteries)
Radio Frequency Band	868.3 MHz / 869.525 MHz
Maximum Radiated Power	10 dBm max.
Receiver category	SRD category 2
Typ. open area RF range	250 m
Duty cycle	< 1 % per h/< 10 % per h
Method of operation	Type 1
Degree of pollution	2



Warmup konekt Wireless 10-Channel Wiring Centre 230V	
The Wiring Centre provides UFH circulator and actuator control based on room, heating/cooling demand.	
It can control up to 10 heating zones/15 actuators or 14 actuators with a UFH circulator.	
It can be mounted using the screws supplied or on a DIN rail.	
Product Code	KW-WC10CH
Supply voltage	230 V AC / 50 Hz
Current consumption	6.3 A max.
IP Rating	IP20
Protection class	I
Ambient temperature	0 - 50°C
Type	1.B.
Dimensions (W x H x D)	225 x 75 x 52 mm
Weight	566 g
Radio frequency band	868.0-868.6 MHz, 869.4-869.65 MHz
Maximum radiated power	10 dBm
Receiver category	SRD category 2
Typ. open area RF range	270 m
Duty cycle	< 1% per h/< 10% per h
Construction	independently mounted electronic regulation and control device, surface mount
Number of heating zones	10
Number of actuators	15 / (14)
Number of pumps	1
Switching capacity per heating zone	1 A max.
Nominal load of all actuators	250 W max.
Type of disconnection	micro
Cable type and cross section	Rigid, flexible cable, 0.75-1.5 mm²
Cable cross section of cable bushing 1	> 5.2 mm
Cable cross section of cable bushing 2	> 8.2 mm
Cable cross section of cable bushing 3	> 3.2 mm
Withstand voltage	2500 V
PTI value of housing	IIIb with 100 < CTI < 175

Warmup konekt Wireless Boiler 2-Channel Switch	
Provides interlock for:	
• UFH demand	
• Radiator demand	
• DHW scheduling	
• Heating and Cooling changeover	
• Dehumidification demand	
Where more than 2 channels are required multiple switches can be used.	
Product Code	KW-BLR2CH
Operating Voltage	230 V AC / 50 Hz
Current Consumption	16 A max.
Standby Power Consumption	< 0.2 W
IP Rating	IP20
Protection Class	I
Ambient Temperature	0 to 50 °C
Load Type	Ohmic load
Max. Switching Capacity	
Switching Channel 1	16 A (3680 W)
Switching Channel 2	5 A (1150 W)
Method of Operation	1.B
Cycle Rating	10,000
Relay	Changeover contact: 1-pole, µ contact NO contact: 1-pole, µ contact
Withstand Voltage	2500 V
Radio frequency band	868.0-868.6 MHz, 869.4-869.65 MHz
Maximum radiated power	10 dBm
Receiver category	SRD category 2
Typ. open area RF range	250 m
Duty cycle	< 1% per h, < 10% per h
Construction	Independently mounted electronic regulation and control device
Degree of Pollution	2

Safety Information

-  Do not use any malfunctioning devices or any devices with visible damage. If you have any doubts, please have the devices checked by a competent professional.
-  Do not open the devices except as instructed to by installation and operation manuals. They do not contain any user serviceable components.
-  For safety and licensing reasons (CE), unauthorised change and/or modification of the device(s) is not permitted.
-  The devices are suitable for indoor use only. They must not be exposed to moisture, vibrations, mechanical loads or temperatures outside of their rated values.
-  The devices and their packaging are not toys; do not allow children to play with them. Small components such as batteries and packaging present a risk of choking or suffocation.
-  Ensure cables are suitably positioned and affixed to prevent risk of tripping or strangulation.
-  Don't attempt to recharge the batteries provided or expose them to temperatures below -20°C or above 55°C. Don't dispose of batteries in a fire or short-circuit them, going so creates a risk of explosion. Used batteries must be disposed in line with local legislation and should be recycled wherever possible.
-  Using the devices, in any way or for any purpose, other than those described their installation and operation manuals invalidates any warranty or liability.
-  These devices are intended for use in residential, business and commercial properties only.
-  The devices do not require product specific maintenance. To clean, use a soft, clean and lint-free cloth. To remove more stubborn marks, dampen the cloth with warm water. Do not use detergents or chemicals on the devices.







Smart Hub

-  Use only the 5V DC, 550mA power supply provided with the device. Connect to an accessible power outlet, such that it can be disconnected without risk in the event of a fault.
-  Connect the Smart Hub with the router using the supplied network cable.

eTRV

-  Please note that the room temperature control via the eTRV is designed for a two pipe heating system with one feed and return line per radiator. Use in single-pipe heating systems can lead to strong deviations in the set temperature due to fluctuations in the flow temperature.

Wiring Centre & Boiler Switch

-  These devices are part of the building installation and must only be installed by appropriately qualified and competent persons in accordance with local regulations and standards.
-  To prevent risk of electric shock, the devices must be disconnected from the mains supply and discharged before conducting any works. Safeguard against the supply being switched back on throughout works.
-  Non-compliance with the installation instructions may result in a fire or an electric shock.
-  The devices may only be used for fixed installations. The devices must be securely attached within a fixed installation.
-  Ensure all cables connected to the devices are correctly sized and rated.
-  Do not exceed the rated loads of each device or any individual output.
-  Manuals for 3rd party devices connected to these, such as heat sources, valves and circulators, must be followed and complied with to ensure compatibility.

The WARMUP word and associated logos are trade marks. © Warmup Plc. 2021 – Regd. ™ Nos. 1257724, 4409934, 4409926, 5265707. E & OE.
Warmup - IM - konekt Wireless - V1.8 2022-09-23_EN

Duty Cycle

The duty cycle is a legally regulated limit of the transmission time of devices in the 868 MHz range. The aim of this regulation is to safeguard the operation of all devices working in the 868 MHz range. In the 868 MHz frequency range we use, the maximum transmission time of any device is 1% of an hour (i.e. 36 seconds in an hour). Devices must cease transmission when they reach the 1% limit until this time restriction comes to an end. Warmup devices are designed and produced with 100% conformity to this regulation. During normal operation, the duty cycle is not usually reached. However, intensively repeated device teach-in processes may mean that this limit is reached in isolated instances during commissioning. If the duty cycle limit is exceeded, the device may stop working for a brief period. The device will start working normally again after a short period (max. 1 hour).

General information about radio operation

Radio transmission is performed on a non-exclusive RF channel, which means that there is a possibility of interference occurring. Interference can also be caused by switching operations, electrical motors or defective electrical devices.

The range of transmission within buildings can differ greatly from that available in the open air. Besides the transmitting power and the reception characteristics of the receiver, environmental factors such as humidity in the vicinity have an important role to play, as do on-site structural/screening conditions.

Declaration of Conformity

 Warmup hereby declares that the Warmup konekt Wireless radio equipment is compliant with Directive 2014/53/EU. Please scan the QR Code for the Declaration of Conformity

Instructions for Disposal

 Do not dispose of the device(s) with regular domestic waste! Electronic equipment must be disposed of at local collection points for waste electronic equipment in compliance with the Waste Electrical and Electronic Equipment Directive.

Warranty

Warmup plc warrants these product(s), to be free from defects in the workmanship or materials, under normal use and service, for a period of three (3) years from the date of purchase by the consumer. If at any time during the warranty period the product is determined to be defective, Warmup shall repair or replace it, at Warmup's option.

If the product is defective, please either;



Return it, with a bill of sale or other dated proof of purchase, to the place from which you purchased it, or Contact Warmup. Warmup will determine whether the product should be returned or replaced.

This warranty does not cover removal or re-installation costs and shall not apply if it is shown by Warmup that the defect or malfunction was caused by failure to follow the instruction manuals, incorrect installation or damage which occurred while the product was in the possession of a consumer. Warmup's sole responsibility shall be to repair or replace the product within the terms stated above.

WARMUP SHALL NOT BE LIABLE FOR ANY LOSS OR DAMAGE OF ANY KIND, INCLUDING ANY INCIDENTAL OR CONSEQUENTIAL DAMAGES RESULTING, DIRECTLY OR INDIRECTLY, FROM ANY BREACH OF ANY WARRANTY, EXPRESS OR IMPLIED, OR ANY OTHER FAILURE OF THIS PRODUCT. THIS WARRANTY IS THE ONLY EXPRESS WARRANTY WARMUP MAKES ON THIS PRODUCT. THE DURATION OF ANY IMPLIED WARRANTIES, INCLUDING THE WARRANTIES OF MERCHANTABILITY AND FITNESS FOR A PARTICULAR PURPOSE, IS HEREBY LIMITED TO THE THREE-YEAR DURATION OF THIS WARRANTY.

This Warranty does not affect your statutory rights.

Symbols Used

-  Hazard indication
-  Important information